

WEATHER DECK DO NOT SCALE DRAWING

THIS DRAWING CONTAINS PROPRIETARY INFORMATION AND DESIGNS OWNED BY SSI, INC. ALL DESIGN, MANUFACTURING, REPRODUCTION, USE, PATENT RIGHTS, AND SALES RIGHTS REGARDING THE SAME ARE EXPRESSLY RESERVED BY SSI, INC.

SYM	REVISION	DATE	BY
A	INITIAL RELEASE	6/23/81	M.J.M.
B	REDRAWN	10/7/82	J.H.W.

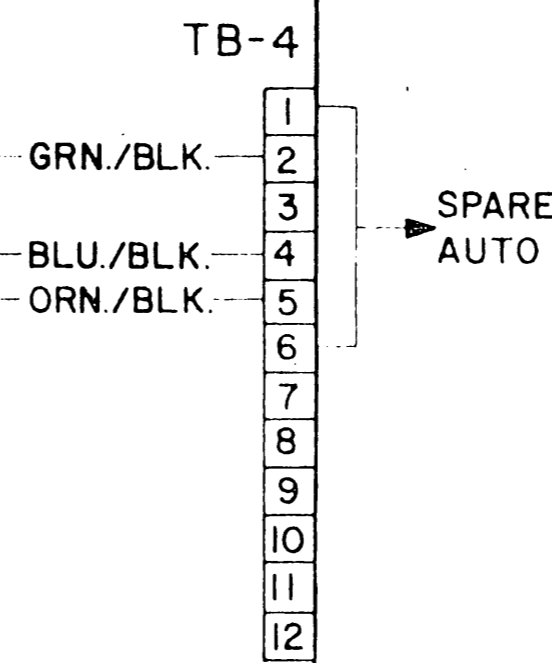
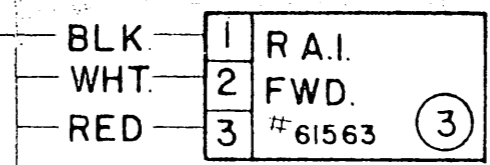
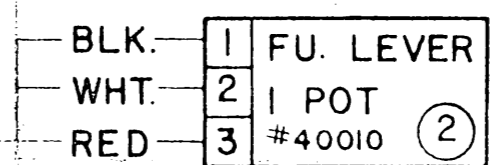
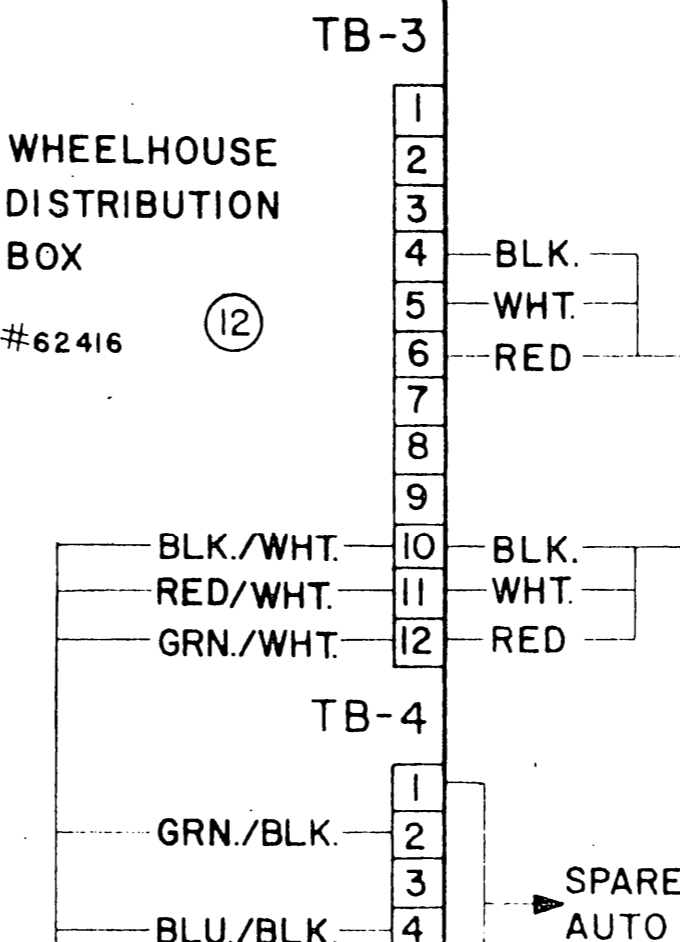
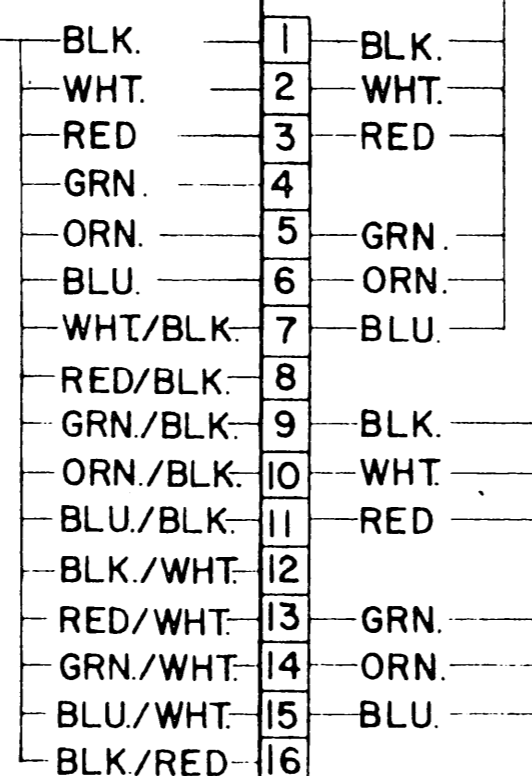
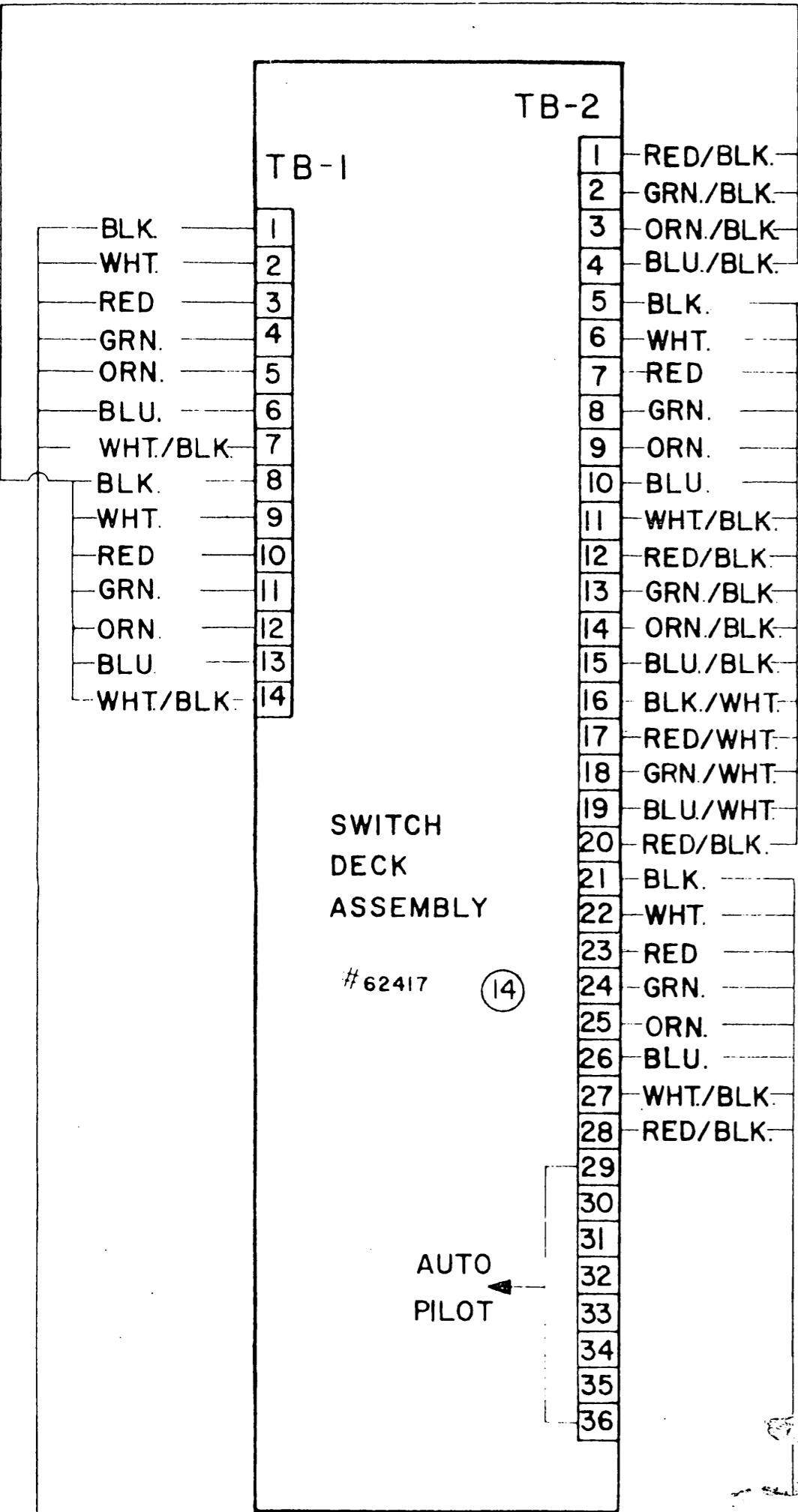
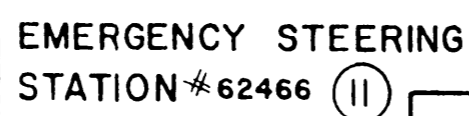
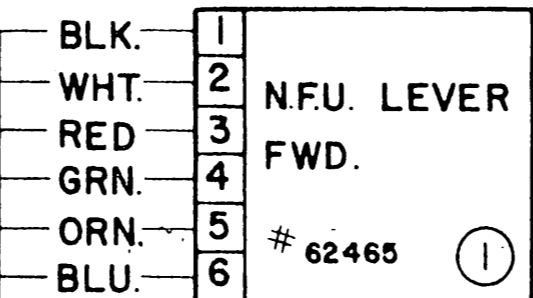
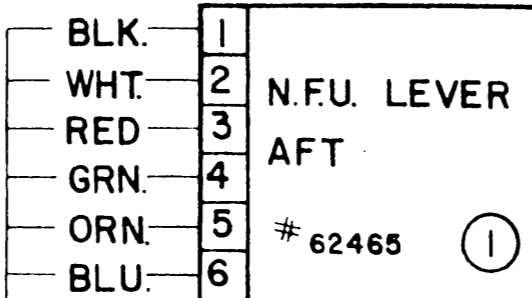

SPARE POT FOR AUTO PILOT (OPTIONAL)

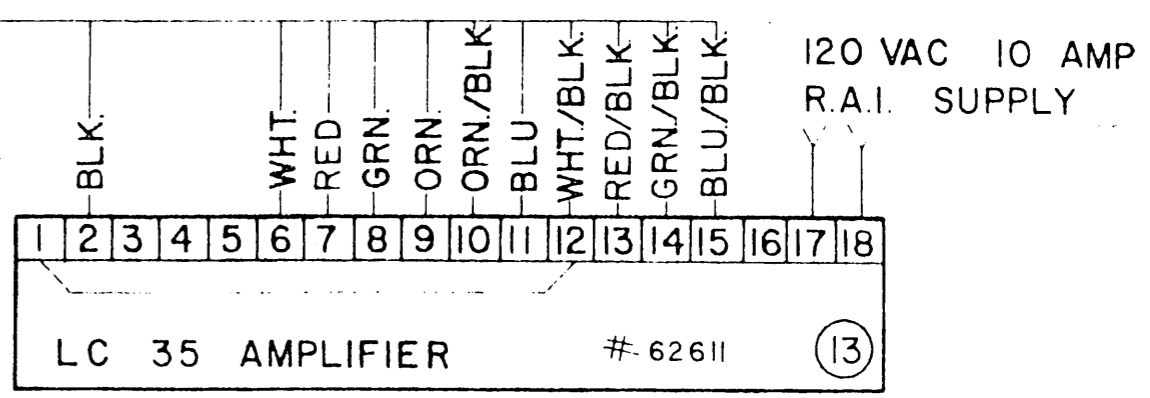
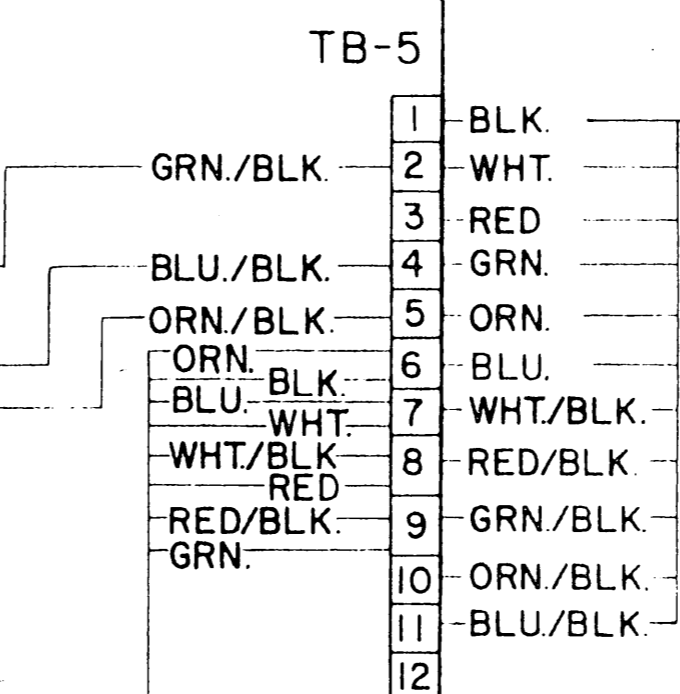
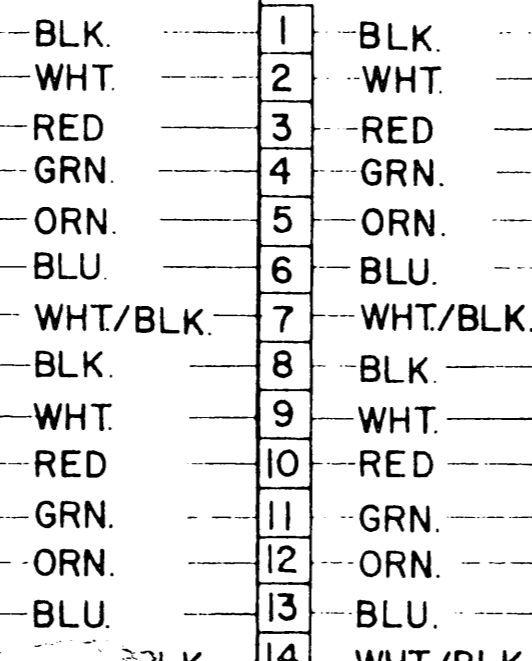

WHEELHOUSE

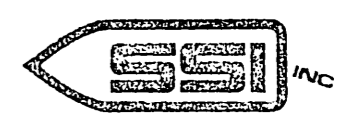
SYM	REVISION	DATE	BY
 HOUMA, LA USA			
<i>Geo Side</i> J. WHITMAN			
10-7-82			
DRAWN BY	CHECKED BY	APP'D BY	APP'D BY
TITLE: WHEELHOUSE WIRING SINGLE AMP SINGLE SPEED			
DRAWING NO: C			